

ORDER CODE	Die Number	Alloy Temper	Length mm	Mass kg/m	Reference
803664	E04273	6060 T5	5000	0.265	A
803663	E04174	6060 T5	5000	0.373	B
803660	E04114	6060 T5	4800	0.235	C
803666	E04338	6060 T5	5000	0.197	D
803610	E01640	6060 T5	5000	0.138	E
803683	E04852	6060 T5	3000	0.722	F
803700	E05426	6060 T5	3000	0.772	G
803651	E03815	6060 T5	3000	0.203	H

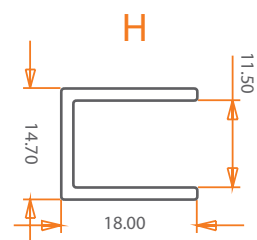
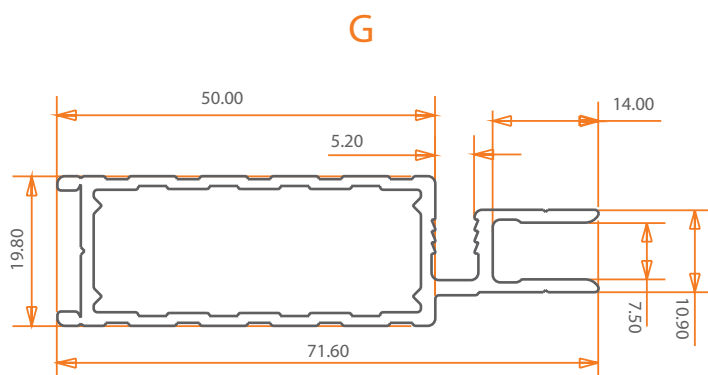
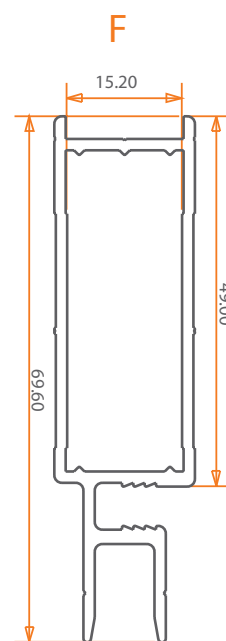
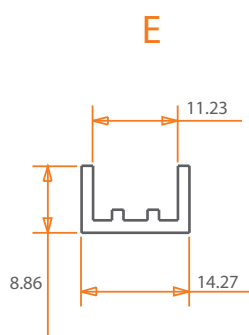
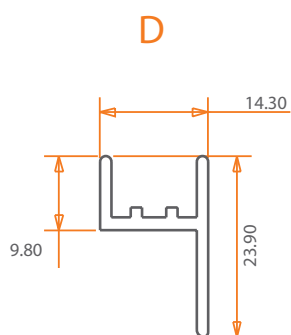
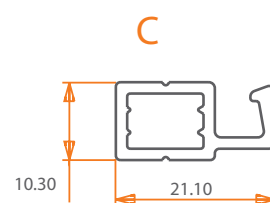
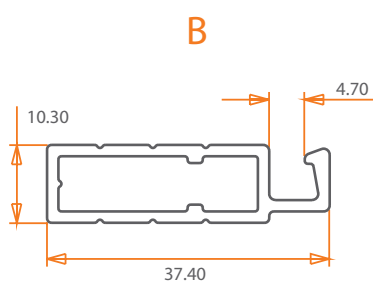
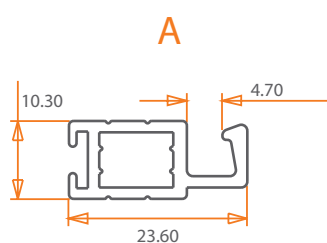

Scale  
shown at  
actual size

# insect & security screens continued...

ORDER CODE	Die Number	Alloy Temper	Length mm	Mass kg/m	Reference
803703	E05553	6060 T5	2300	0.408	A
803704	E05554	6060 T5	3000	0.493	B
803706	E05594	6060 T5	5000	0.313	C
803665	E04337	6060 T5	5000	0.232	D
803707	E05595	6060 T5	5000	0.293	E
803725	E06179	6060 T5	5000	0.350	F
803759	E07676	6060 T5	5000	1.084	G

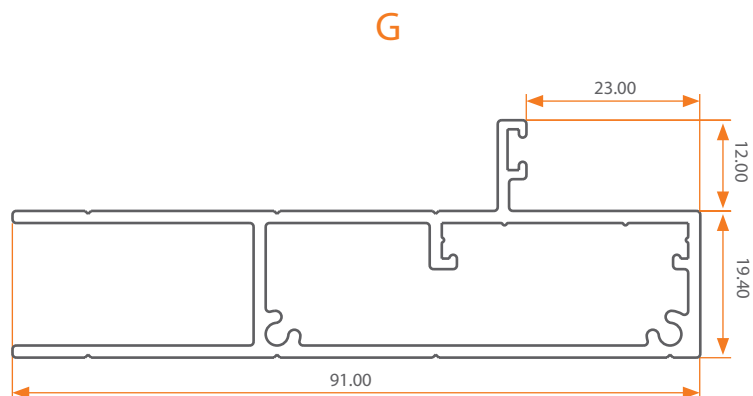
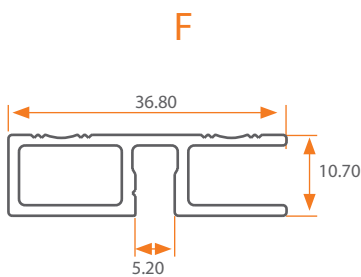
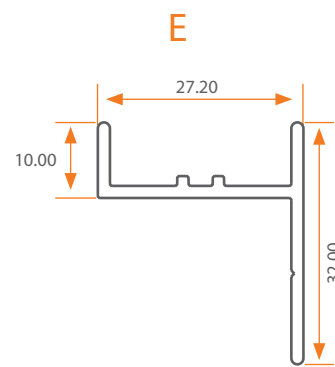
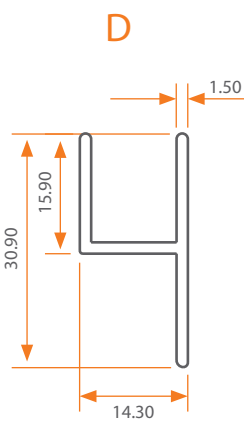
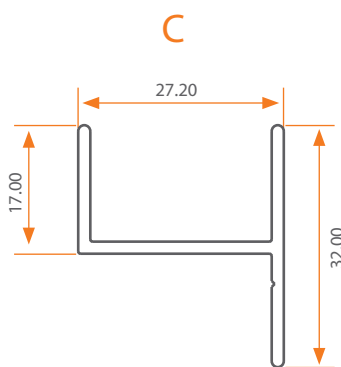
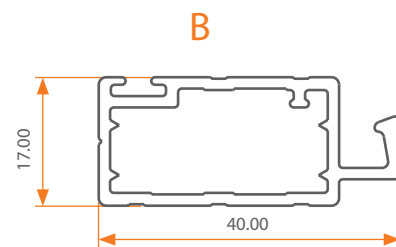
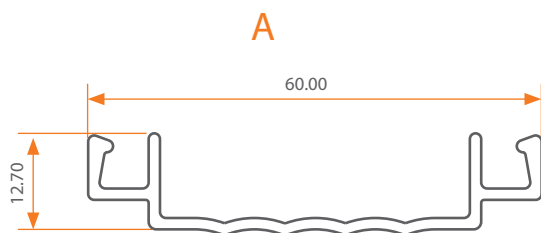

EXTRUDED PRODUCTS