

# misc architectural profiles

Scale  
shown at  
actual size

REFERENCE	A	B	C	D	E	F
<b>ORDER CODE (Die Number)</b>	E03352	E07125	E07698	E04886	E03637	E06839
Mass kg/m	0.228	0.343	0.239	1.220	0.864	1.536

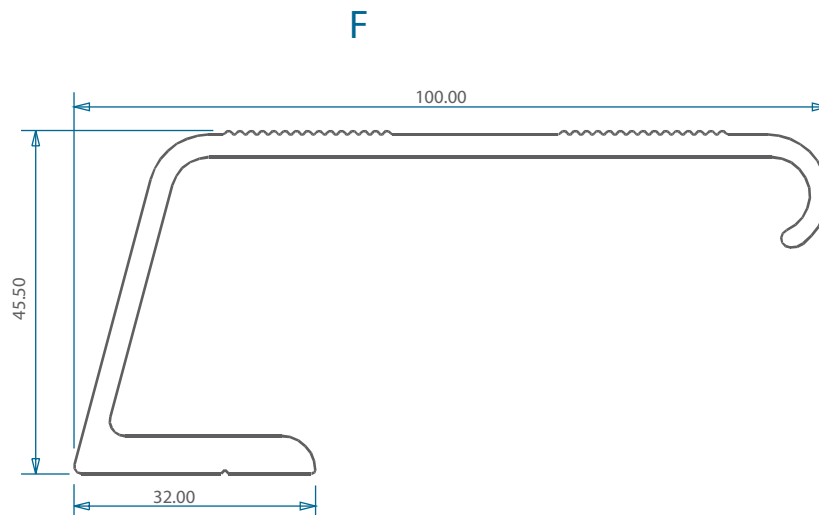
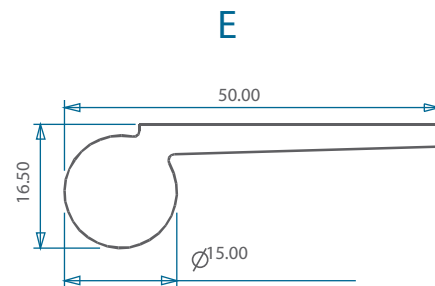
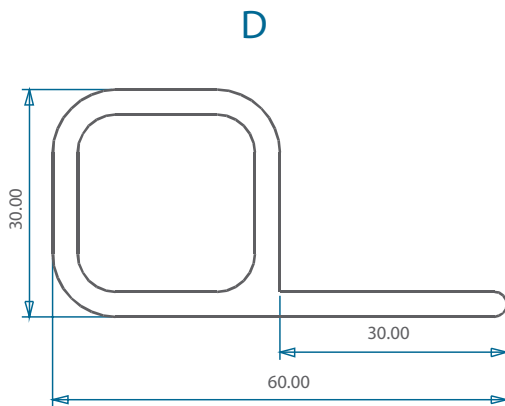
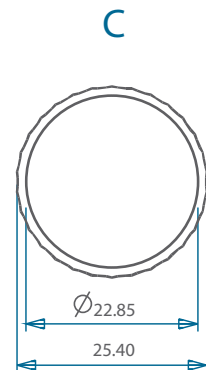
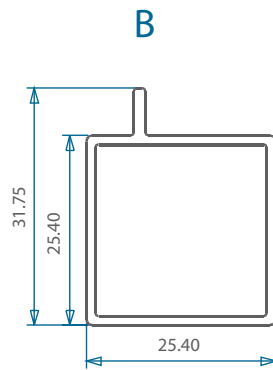
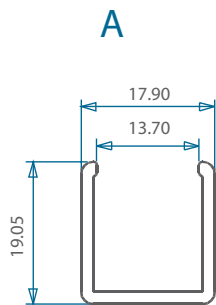

Scale  
shown at  
actual size

# misc architectural profiles continued...

REFERENCE	A	B	C	D	E	F	G	H
<b>ORDER CODE (Die Number)</b>	E00358	E00408	E01188	E01210	E01248	E01723	E02731	E03270
Mass kg/m	0.138	0.298	0.513	0.416	0.323	0.138	0.212	0.222

**A**

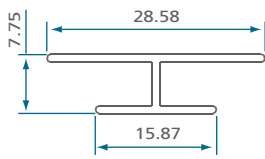

**B**

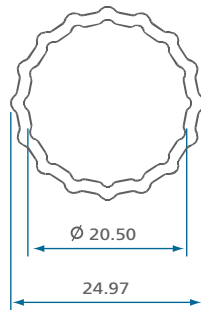

**C**

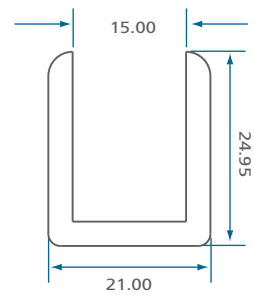

**D**

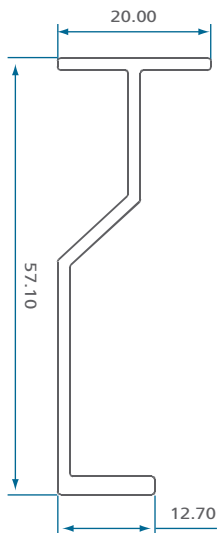

**E**

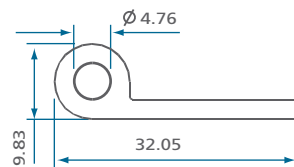

**F**

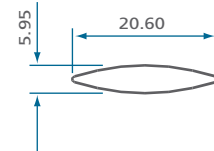

**G**

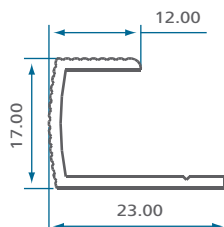

**H**

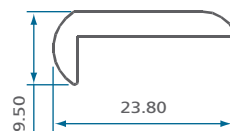

EXTRUDED PRODUCTS

# misc architectural profiles continued...

Scale shown at actual size

REFERENCE	A	B
<b>ORDER CODE</b> (Die Number)	E03398	E03072
Mass kg/m	3.160	3.530

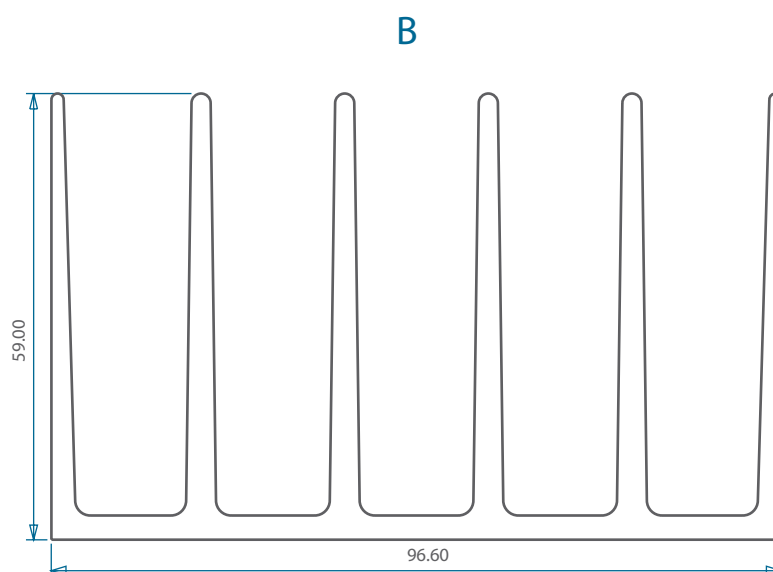
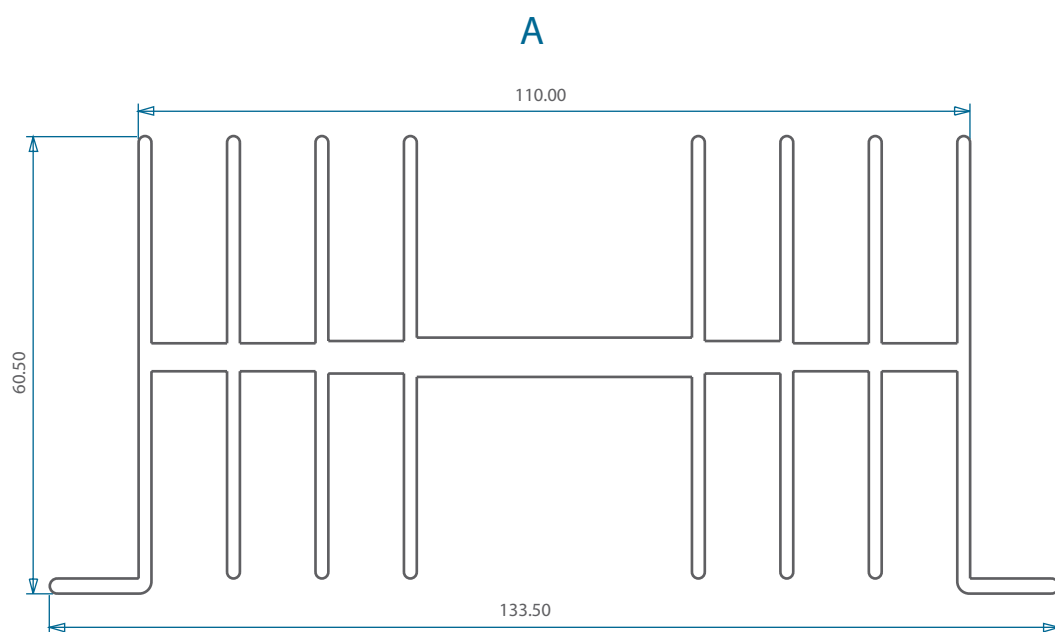

Scale  
shown at  
actual size

# misc architectural profiles continued...

REFERENCE	A	B	C	D	E
<b>ORDER CODE (Die Number)</b>	E03694	E04910	E02468	E05046	E04391
Mass kg/m	0.888	0.291	1.360	1.128	1.423

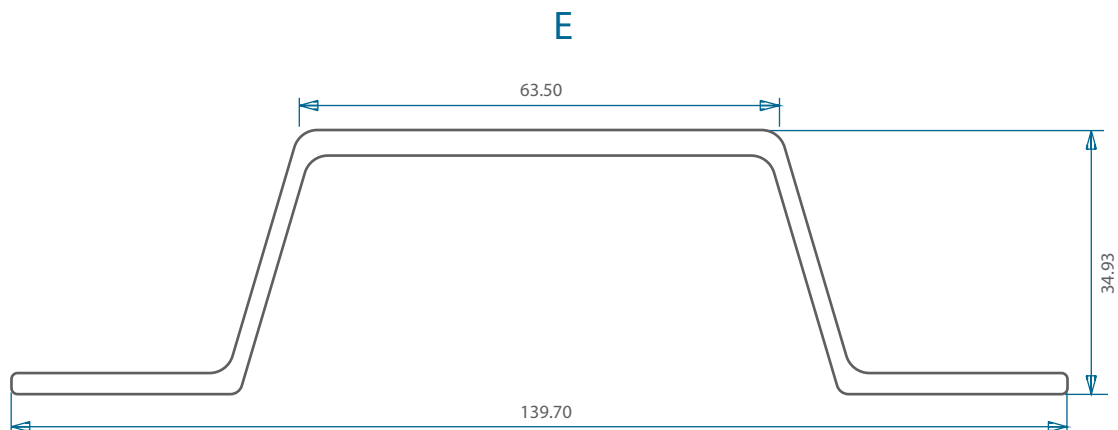
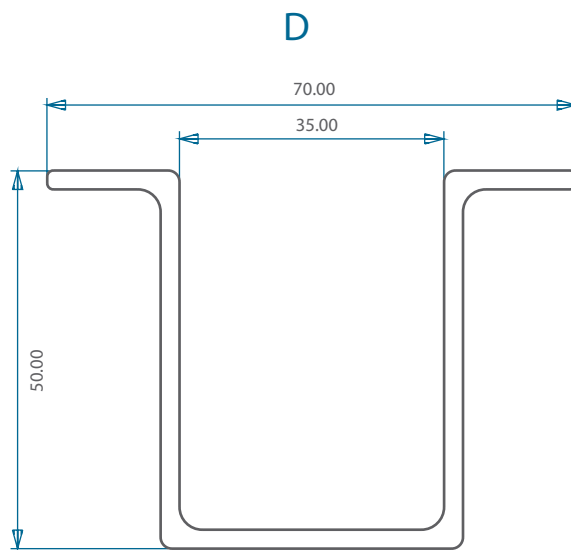
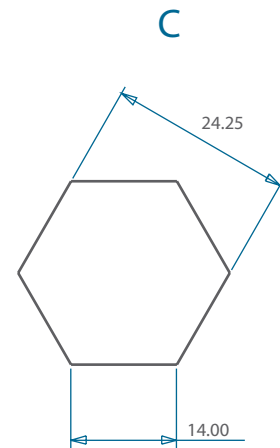
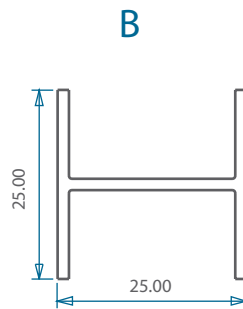
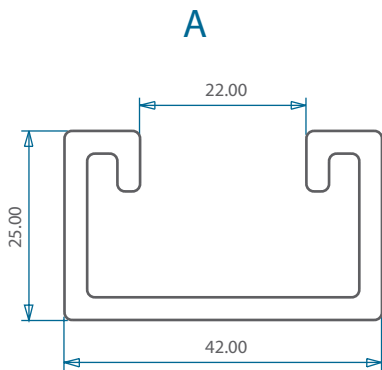

EXTRUDED PRODUCTS

# misc architectural profiles continued...

Scale shown at actual size

REFERENCE	A	B	C	D	E
<b>ORDER CODE (Die Number)</b>	E00105	E09142	E04480	E04481	E03839
Mass kg/m	0.128	0.153	0.853	1.470	0.832

**A**

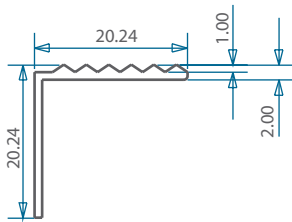

**B**

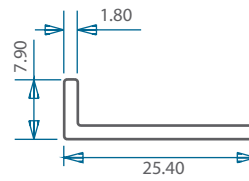

**C**

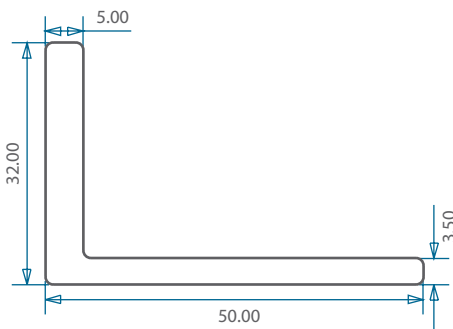

**D**

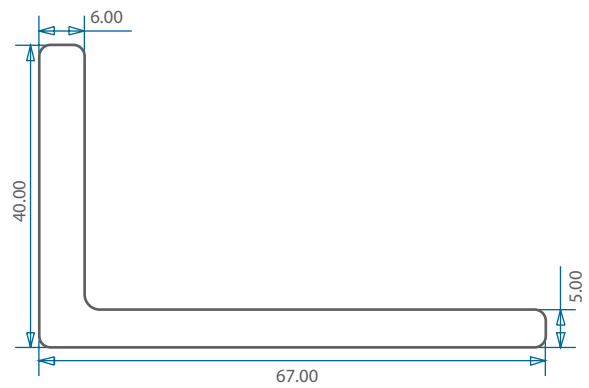

**E**

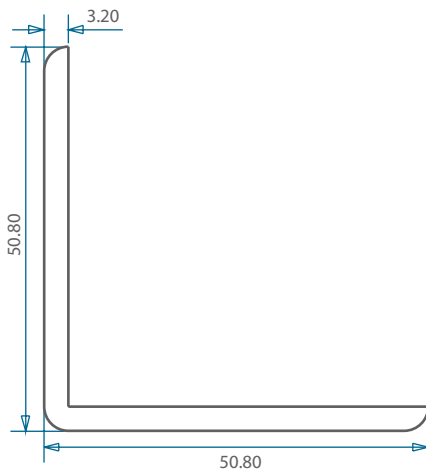

Scale  
shown at  
actual size

# misc architectural profiles continued...

REFERENCE	A	B	C	D	E
<b>ORDER CODE (Die Number)</b>	E01067	E01188	E00186	E12003	E12004
Mass kg/m	0.496	0.513	0.885	0.189	0.196

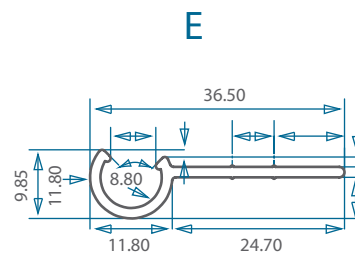
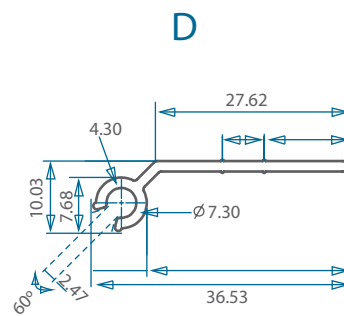
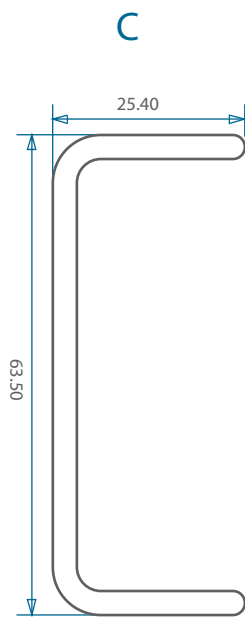
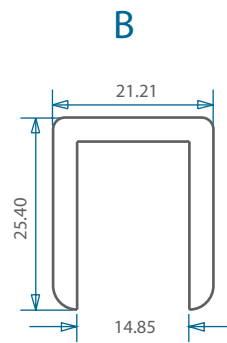
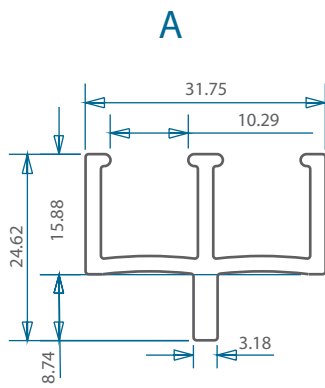

EXTRUDED PRODUCTS

# misc architectural profiles continued...

Scale shown at actual size

REFERENCE	A	B
<b>ORDER CODE (Die Number)</b>	E02311	E08314
Mass kg/m	3.073	1.504

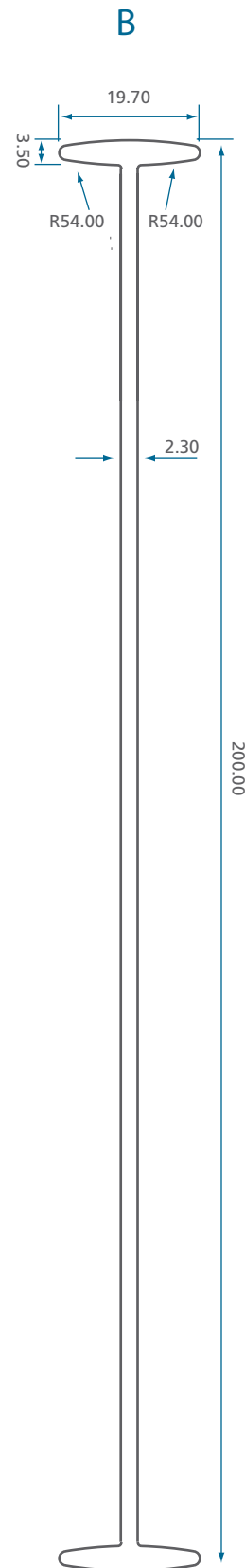
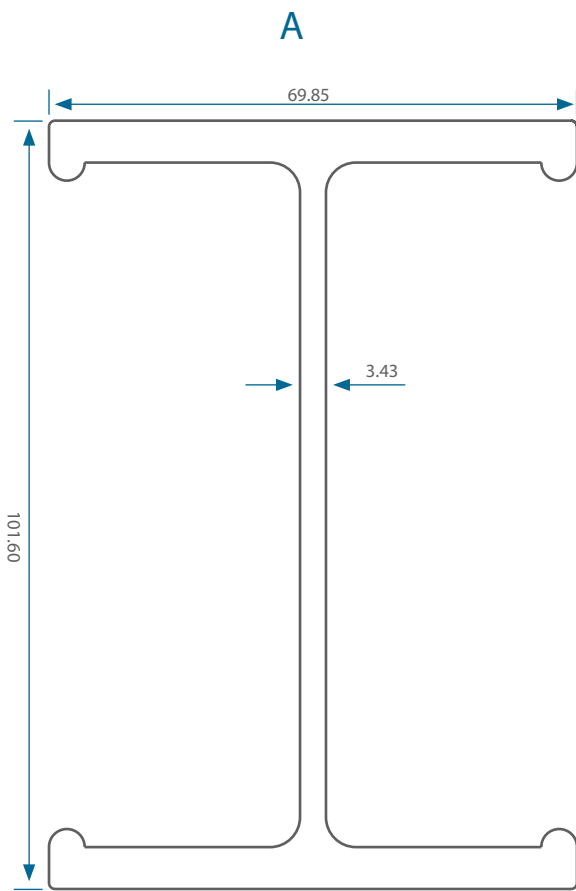

Scale  
shown at  
actual size

# misc architectural profiles continued...

REFERENCE	A	B	C	D	E
<b>ORDER CODE (Die Number)</b>	E04215	E05903	E00084	E00085	E00178
Mass kg/m	0.850	1.704	0.321	0.705	1.300

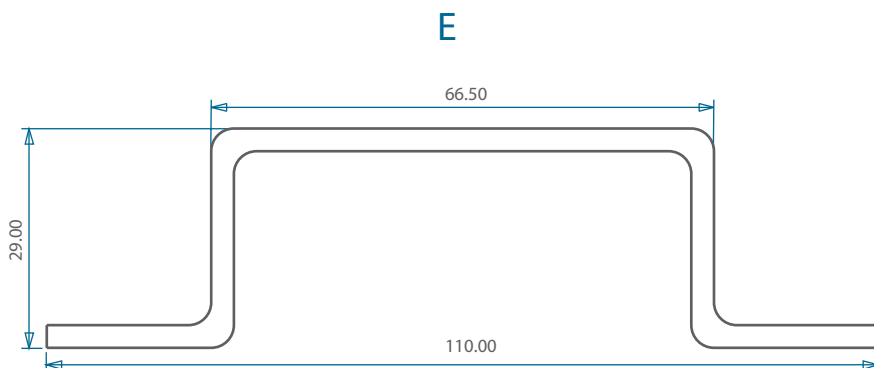
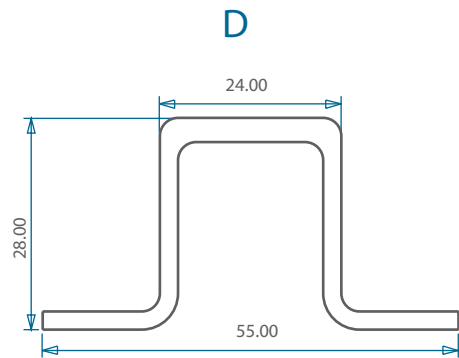
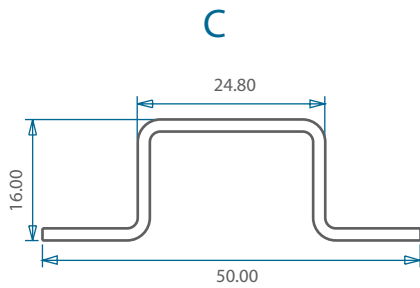
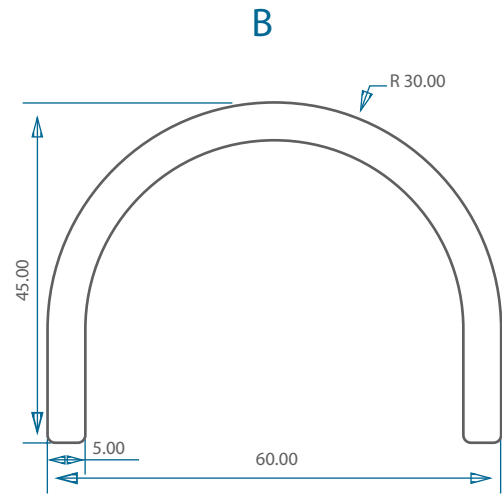
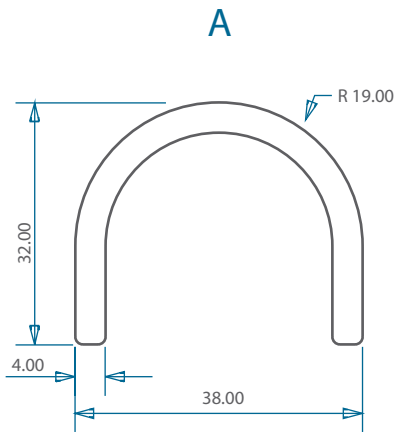

EXTRUDED PRODUCTS

# misc architectural profiles continued...

Scale shown at actual size

REFERENCE	A	B	C	D	E	F
<b>ORDER CODE (Die Number)</b>	E00180	E01033	E00088	E00622	E11656	E11655
Mass kg/m	0.652	0.249	0.390	0.933	0.150	0.094

**A**

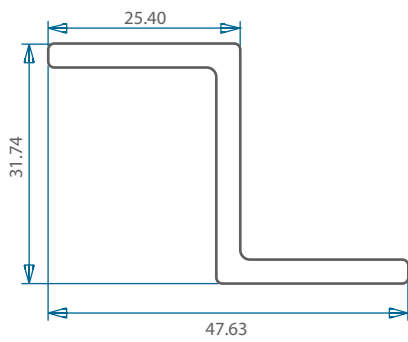

**B**

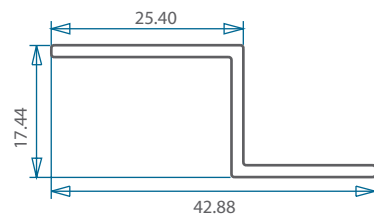

**C**

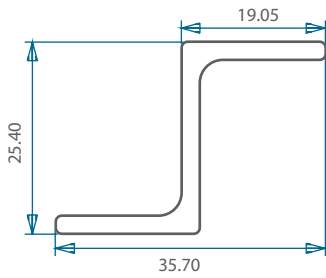

**D**

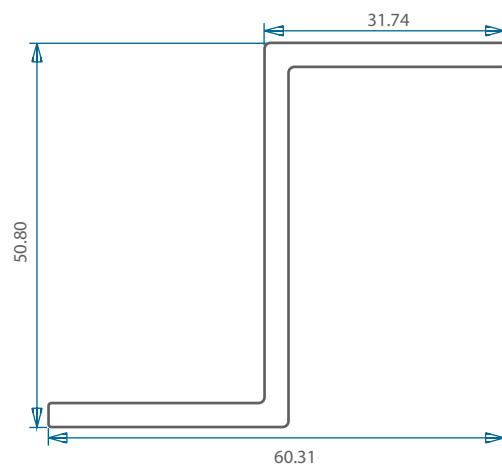

**E**

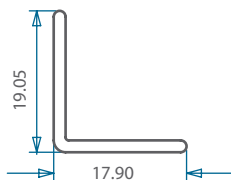

**F**

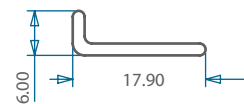

Scale  
shown at  
actual size

# misc architectural profiles continued...

REFERENCE	A	B	C	D
<b>ORDER CODE (Die Number)</b>	E06032	E12122	E05442	E12244
Mass kg/m	0.477	1.575	0.642	3.200

**A**

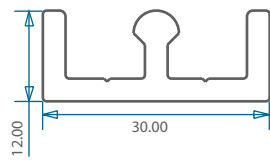

**B**

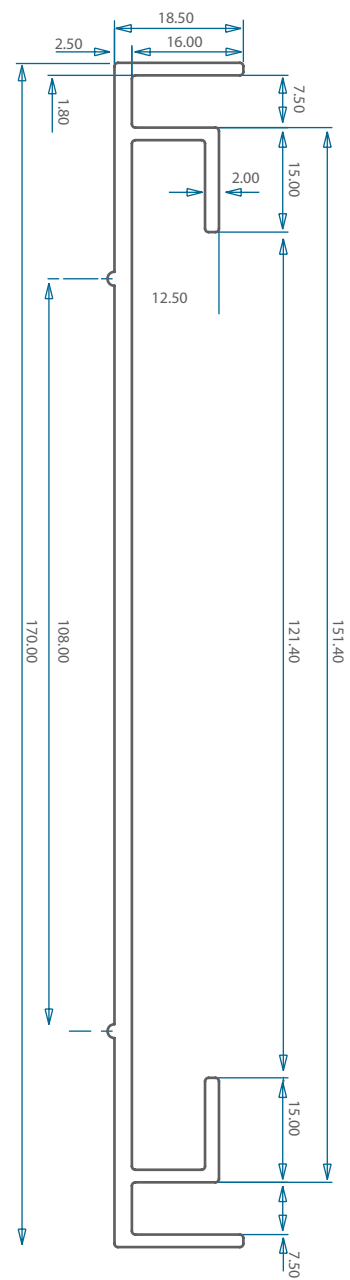

**C**

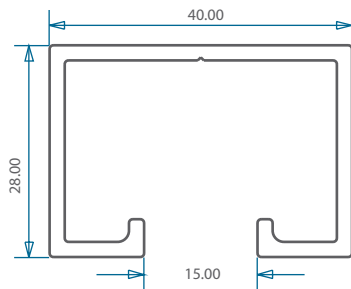

**D**

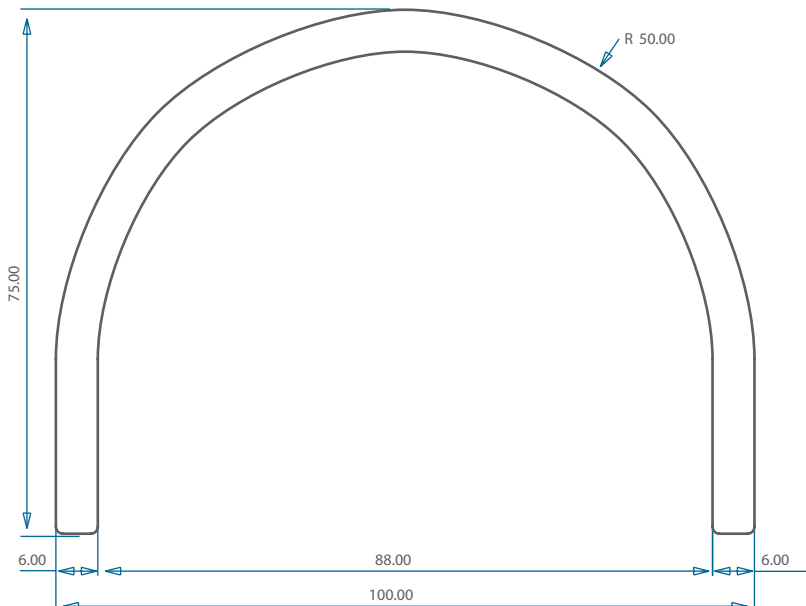

EXTRUDED PRODUCTS

# misc architectural profiles continued...

Scale shown at actual size

REFERENCE	A	B	C	D	E	F
<b>ORDER CODE (Die Number)</b>	E11691	E11733	E11841	E11686	E11787	E11710
Mass kg/m	1.336	0.087	0.951	1.275	1.599	0.134

A

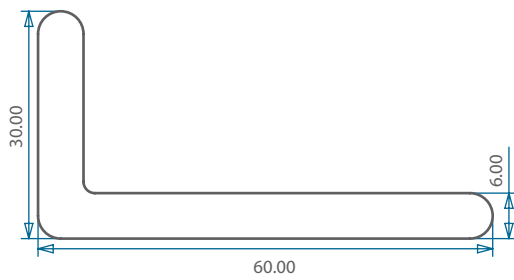

B

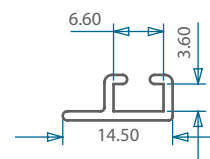

C

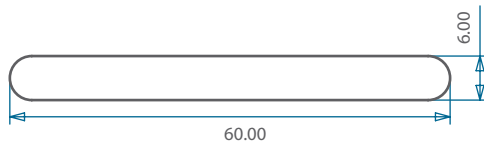

D

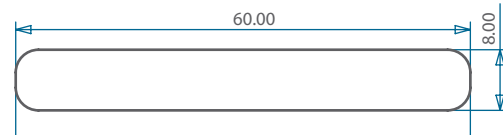

E

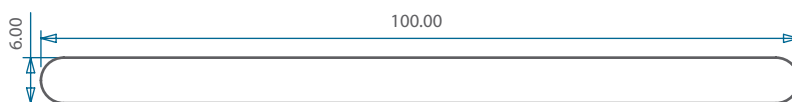

F

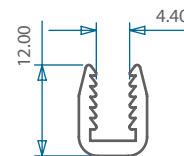

Scale  
shown at  
actual size

# misc architectural profiles continued...

REFERENCE	A	B	C
<b>ORDER CODE (Die Number)</b>	E03867	E11872	E11873
Mass kg/m	1.300	0.321	0.322

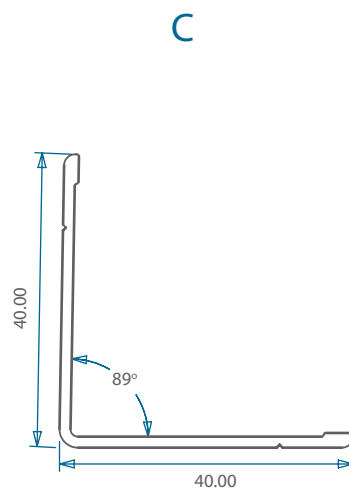
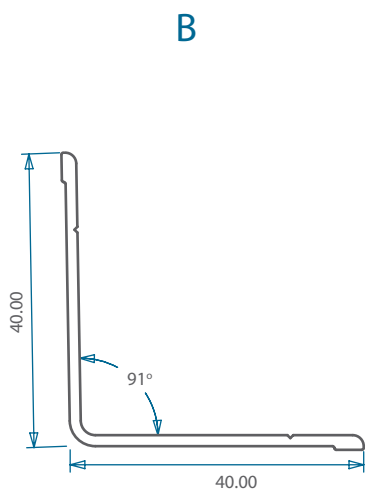
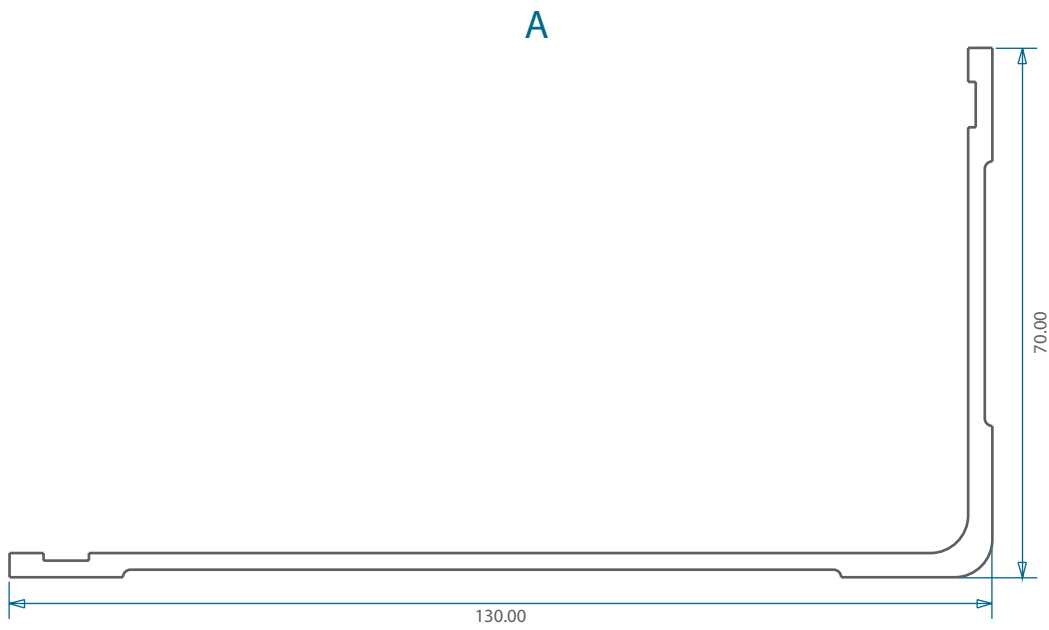

EXTRUDED PRODUCTS

# misc. architectural profiles

Scale shown at actual size

REFERENCE	A	B	C
<b>ORDER CODE</b> (Die Number)	E11968	E11967	E11966
Mass kg/m	0.542	0.434	0.609

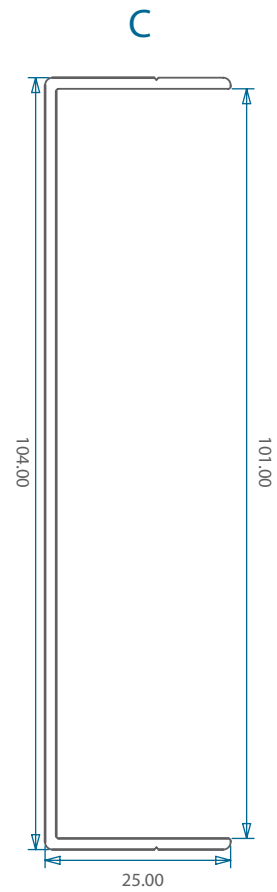
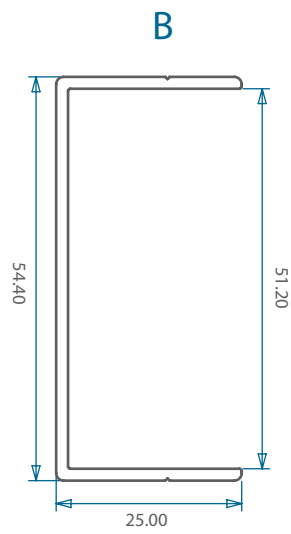
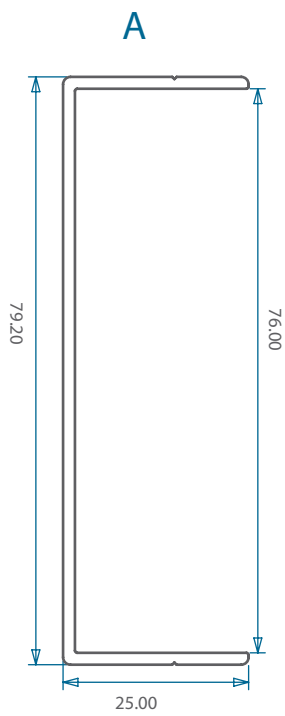

Scale  
shown at  
actual size

# misc architectural profiles continued...

REFERENCE	A	B
<b>ORDER CODE (Die Number)</b>	E12808	E12809
Mass kg/m	0.445	0.893

A

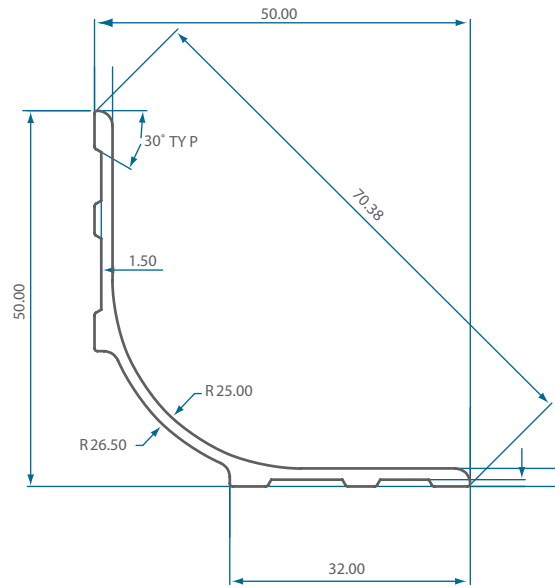

B

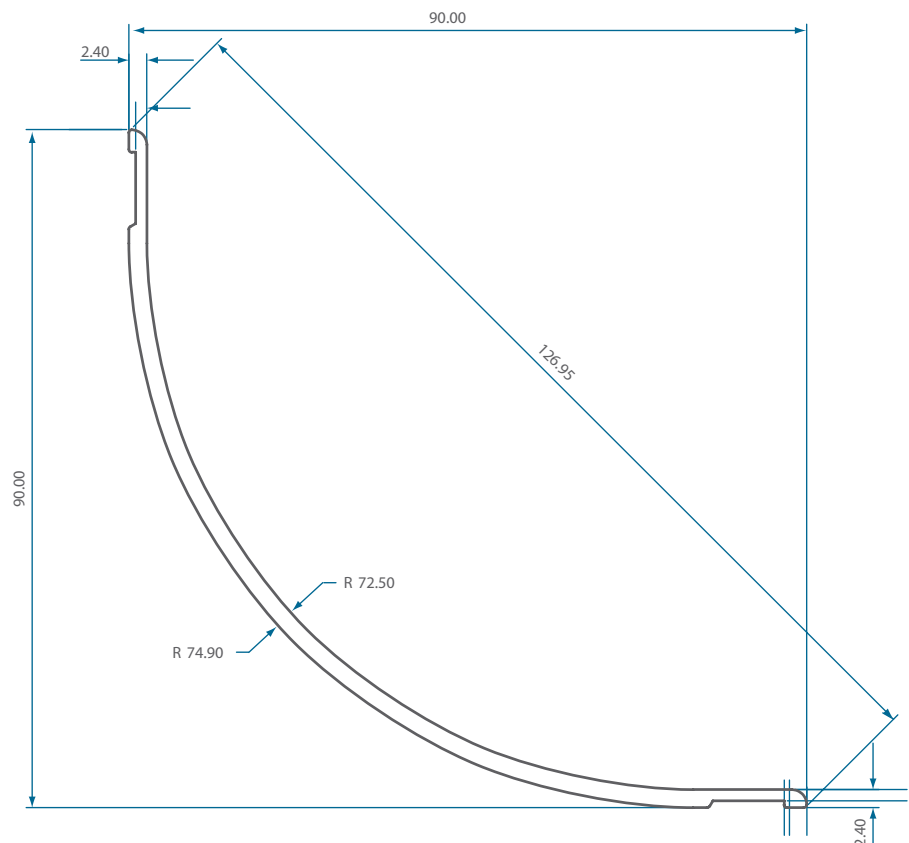

EXTRUDED PRODUCTS

# misc architectural profiles continued...

Scale shown at actual size

REFERENCE	A	B
<b>ORDER CODE (Die Number)</b>	E12814	E12815
Mass kg/m	1.267	1.420

A

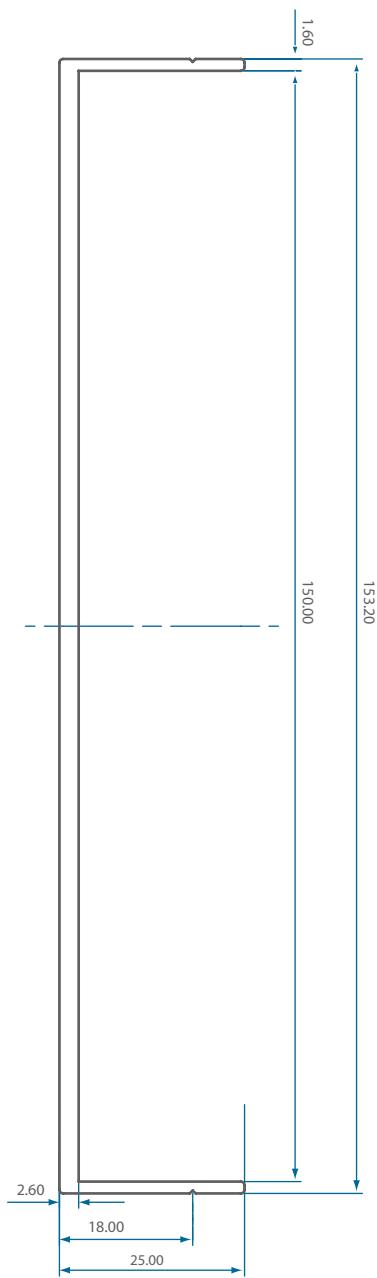

B

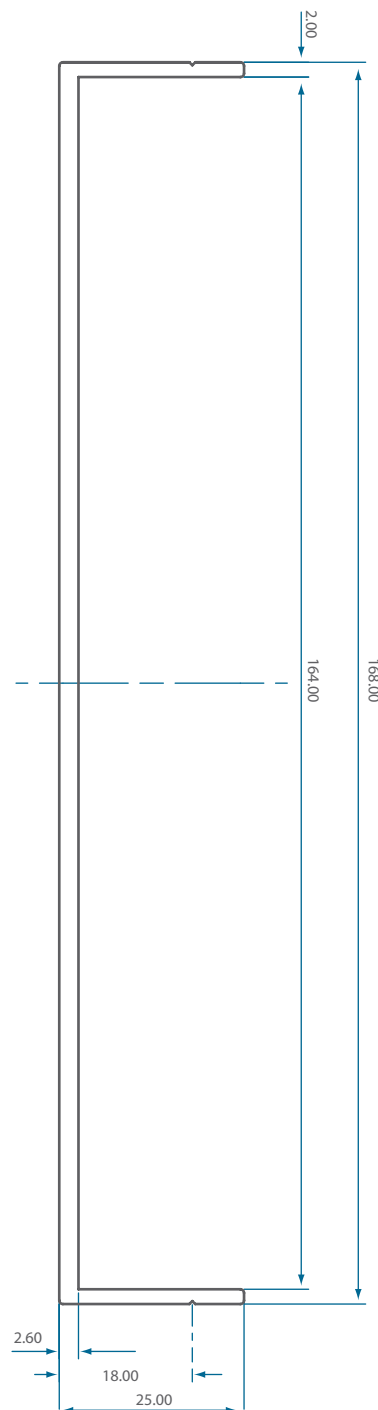

Scale  
shown at  
actual size

# misc architectural profiles continued...

REFERENCE	A	B
<b>ORDER CODE</b> (Die Number)	E12812	E12813
Mass kg/m	0.588	0.849

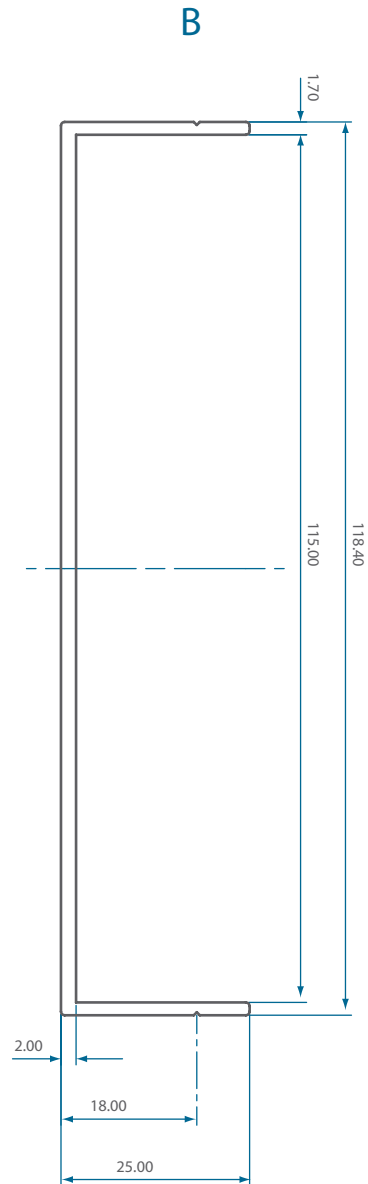
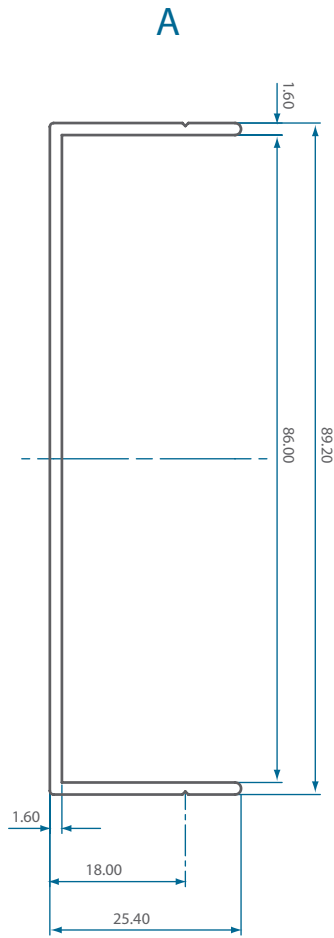

EXTRUDED PRODUCTS