

Scale
shown at
actual size

transport shapes

REFERENCE	A	B	C	D	E	F	G
DIE NUMBER (order code)	E03490	E00111	E00236	E01724	E00267	E03609	E00266
Mass kg/m	0.191	0.305	0.198	0.248	0.546	0.359	1.340

A

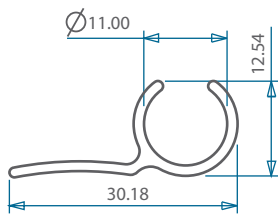

B

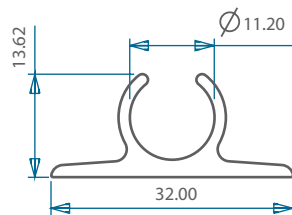

C

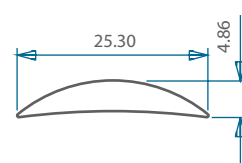

D

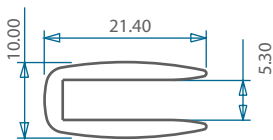

E

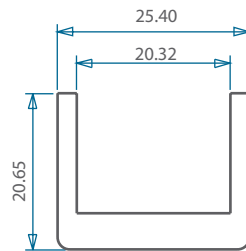

F

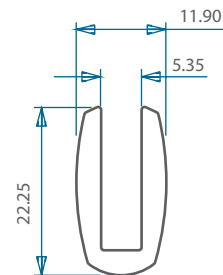

G

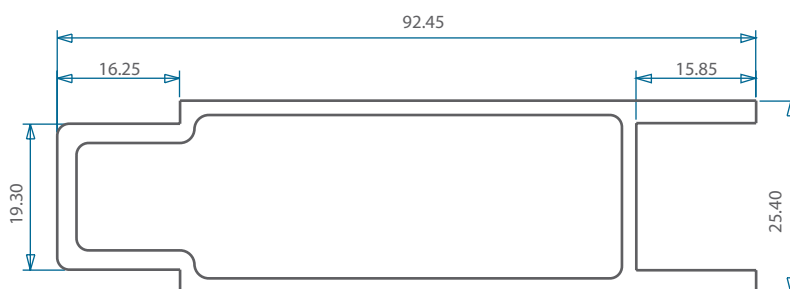

EXTRUDED PRODUCTS

REFERENCE	A	B
ORDER CODE (Die Number)	E01180	E04128
Mass kg/m	2.350	5.610

A

B

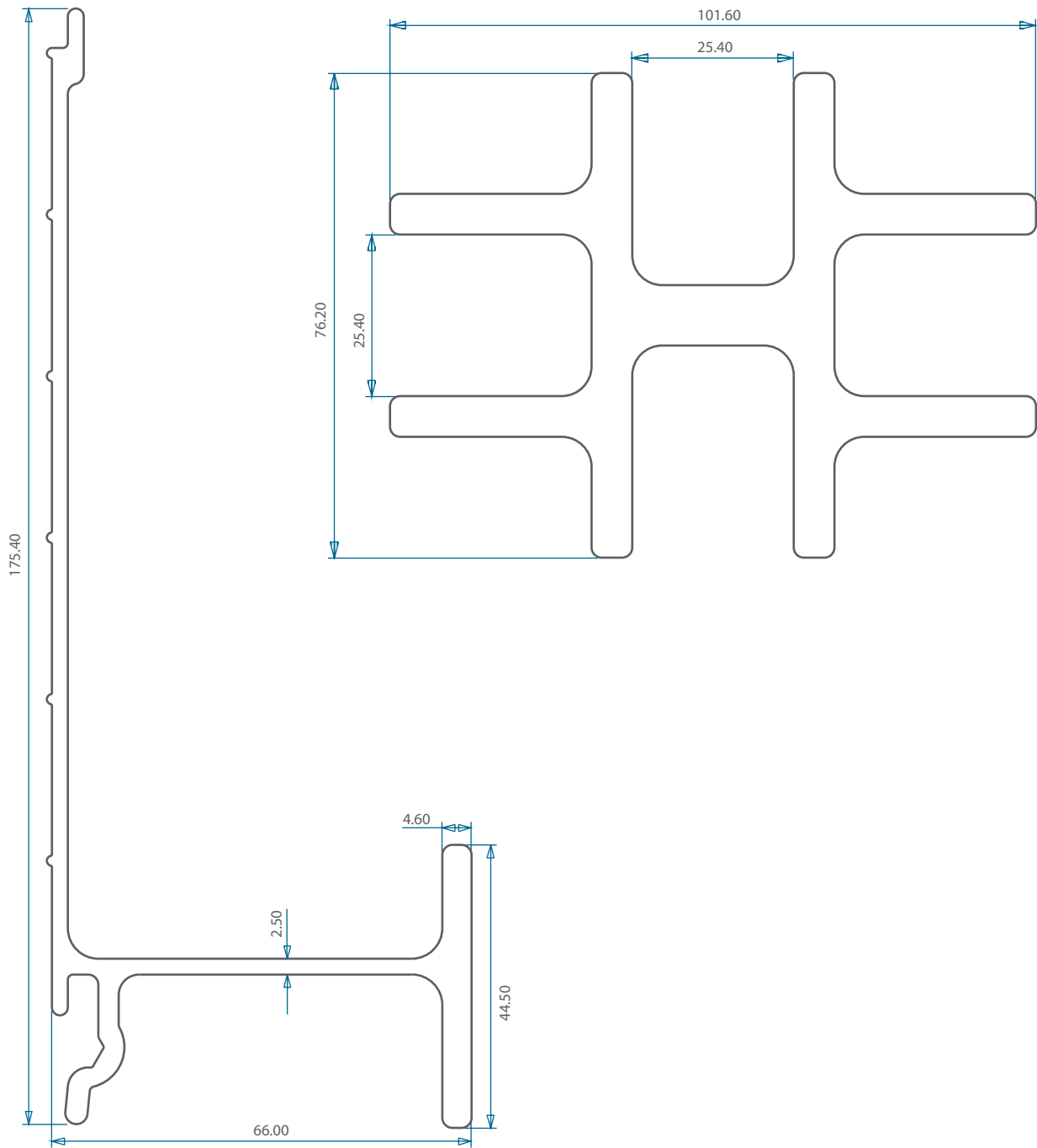

Scale
shown at
actual size

transport shapes continued...

REFERENCE	A	B	C	D
ORDER CODE (Die Number)	E00229	E00100	E01953	E10172
Mass kg/m	0.396	0.450	2.080	0.453

A

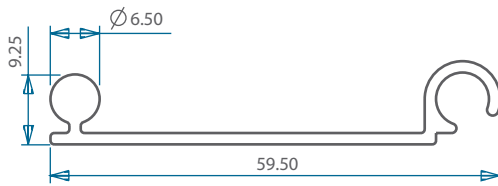

B

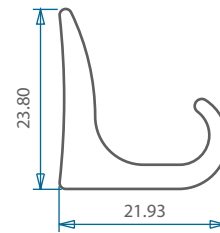

C

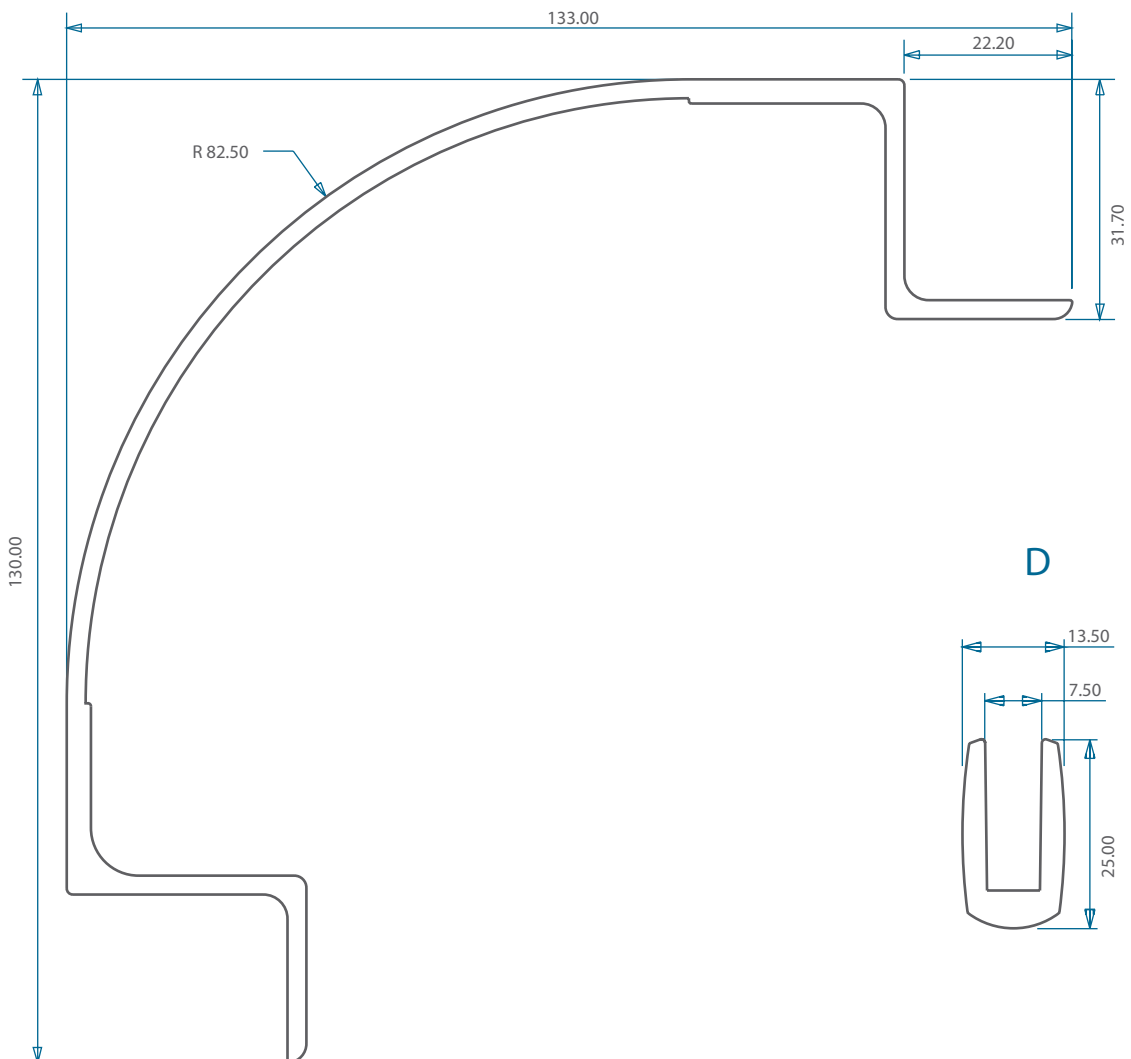

D

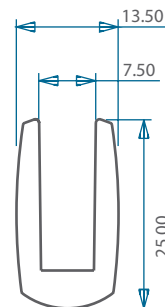

EXTRUDED PRODUCTS

transport shapes continued...

Scale shown at actual size

REFERENCE	A	B	C
ORDER CODE (Die Number)	E03729	E02186	E03764
Mass kg/m	2.680	2.070	3.119

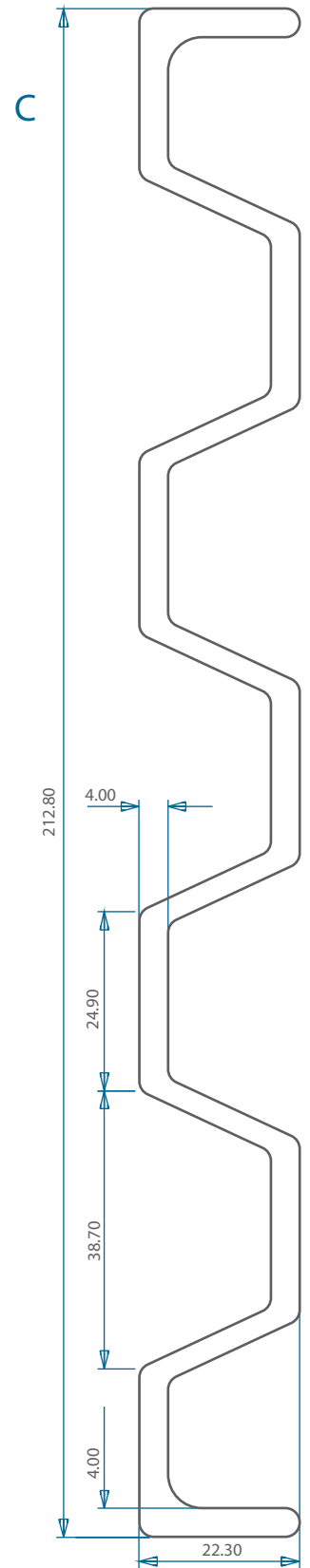
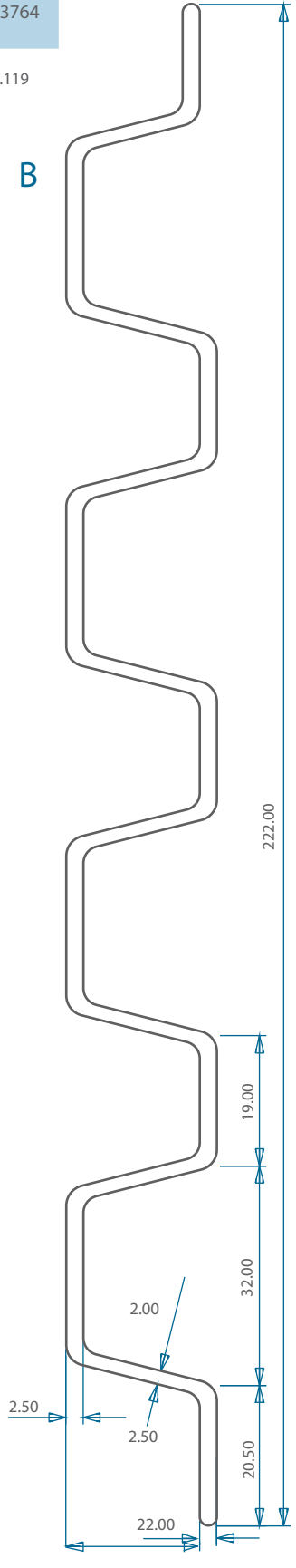
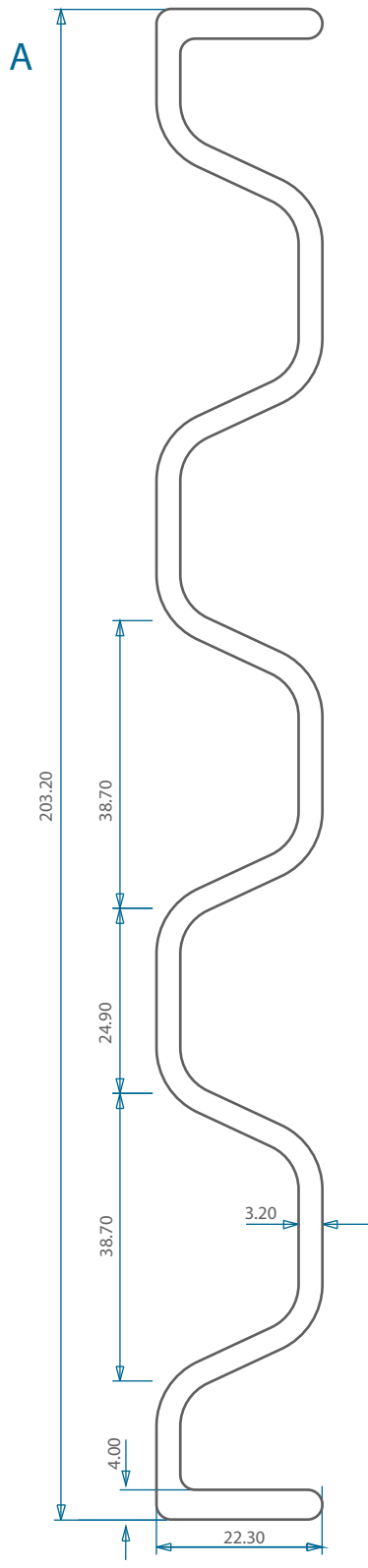

Scale
shown at
actual size

transport shapes continued...

REFERENCE	A	B
ORDER CODE (Die Number)	E05772	E05773
Mass kg/m	4.822	5.030

A

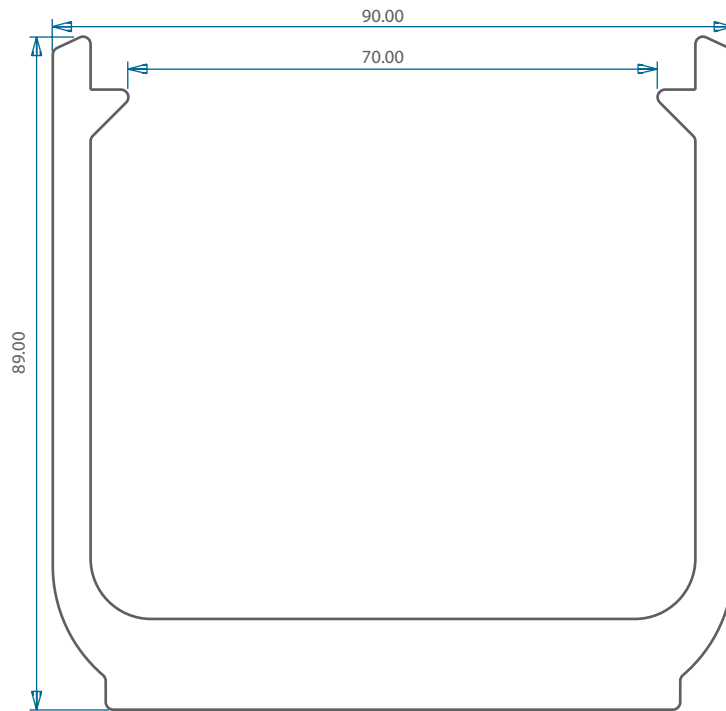

B

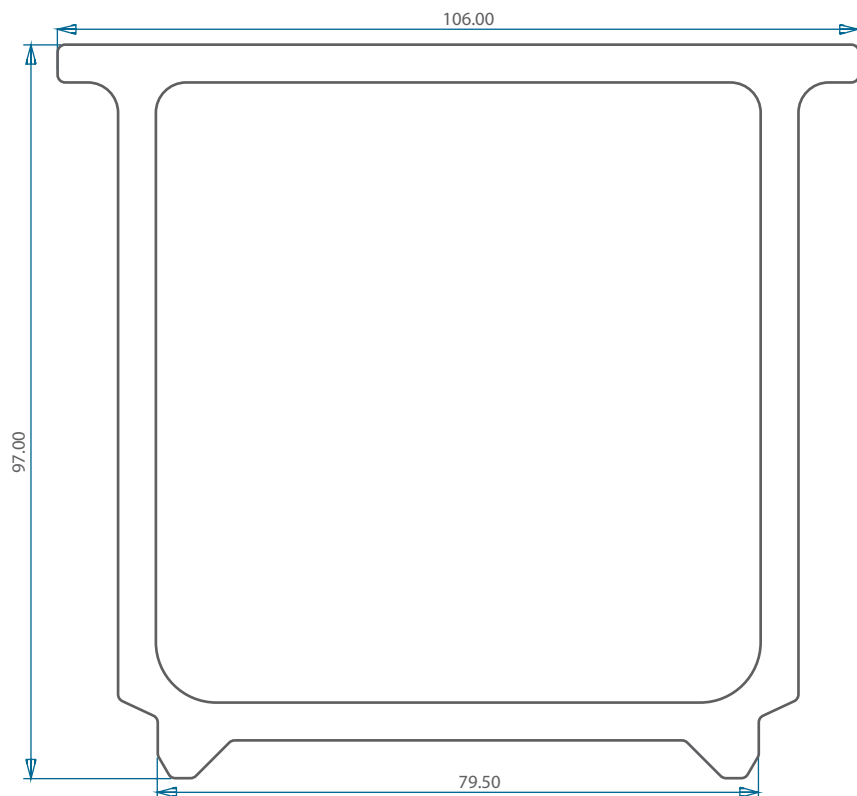

EXTRUDED PRODUCTS